

## WARRANTY

This Awning is covered by a 12 month warranty. The Company undertakes to replace or repair, free of charge, any defect which the Company considers to be due to faulty workmanship or material within 12 months of the purchase date, except for:

- Defects arising from neglect, misuse or unauthorised modifications.
- Damage caused by storm, abuse, misuse, dropping or other similar damage caused by or as a result of failure to follow storage or erection instructions.
- Unauthorised alterations, additions or repairs.
- Transportation or shipment costs to and from the Manufacturer or their recognised agents, for repair or assessment against a warranty claim.
- Damage caused due to UV degradation.
- Materials and/or labour costs to renew, repair or replace components due to fair wear and tear or condensation.
- Awnings used on permanent sites or displays.

THIS DOES NOT AFFECT YOUR STATUTORY RIGHTS.

The Manufacturer and/or their recognised agents, directors, employees or insurers will not be held liable for consequential or other damages, losses or expenses in connection with or by reason of or the inability to use the awning for any purpose.

NOTE; Any claim(s) arising due to missing parts or faulty goods MUST be made before use. The manufacturer will not be responsible for any claims regarding missing parts or faulty items where the product has not been checked by the user prior to use.



# SunnCamp

## VISION/VISION XL/ASPECT AWNING

*Thank you for purchasing the Vision/Vision XL/Aspect Awning from SunnCamp.*

*Before erecting this awning, carefully read and understand these instructions. If there is anything you do not understand, contact your retailer for advice.*

*By following the instructions on erecting, dismantling, packing and storing the awning you will enjoy many years of trouble free camping.*

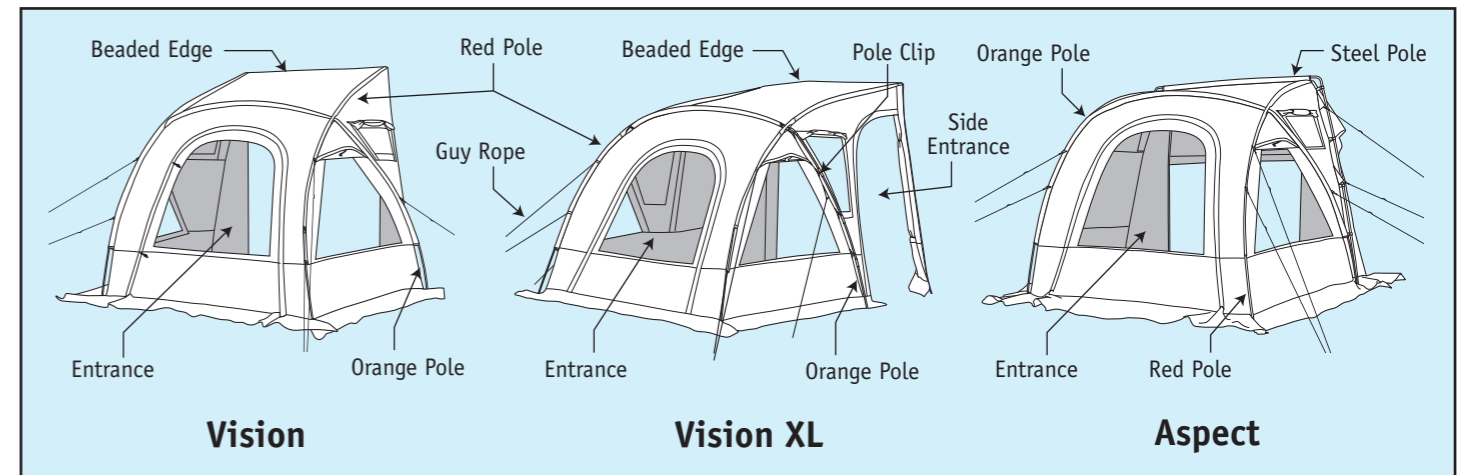

### PARTS LISTING

Your Vision, Vision XL or Aspect Awning consists of the following items and you should check everything is present before setting off.

Awning Flysheet	1
Red Shock Corded Pole	2
Orange Shock Corded Pole	1
Awning Peg Bag	1
Repair Kit	1
Awning Carry-Bag	1
<b>ASPECT ONLY</b>	
Steel End Pole Set	1

It is a requirement of the warranty that you unpack and erect this Awning at home prior to proper use. This will

enable you to familiarise yourself with the Awning and check all parts are present and in good condition.

If you find any part missing or a fault with your awning, contact the retailer before returning or using it.

### SITE SELECTION

Choose a location where the ground is flat, clean, smooth and dry. Position the awning entrance away from the direction of the wind. Do not position on sharp, rocky or rough ground.

### GETTING STARTED

Unpack the awning and place the carry-bag somewhere safe. Separate all components and check that everything is present.

You should now ensure that all entrances to the awning are closed with all zips fully secured. If this is not done now, the awning will be out of alignment when fitting the awning pegs.

## POLES

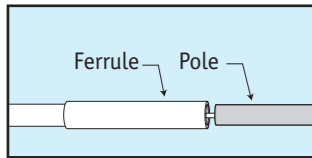

Take each Shock Corded Pole and slot together.

The Poles are folded down to aid storage. When fitting the pole sections together, make sure that the pole body is fully inserted into its adjoining ferrule.

To ensure that all poles are inserted into the correct sleeve, both pole and sleeve carry the same colour coding.

Note that the orange pole has two elbow sections, which create the awning's roof shape.

## AWNING

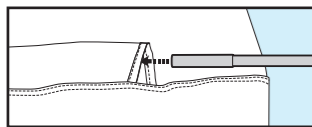

Lay the awning out on the selected ground area with the entrance correctly positioned.

### VISION & VISION XL ONLY

Slide the beaded rear edge into the caravan's awning channel.

Insert the Orange pole into the sleeve marked with an orange band.

Insert the two red shock corded poles into the sleeves marked with a red band. The poles ends are held captive at the end of the sleeve by a reinforced pocket.

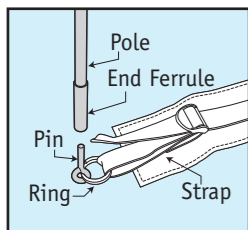

Each pole end is held captive by a pin on a ring fitted to the end of an adjustable webbing strap.

The ring is also used as the securing point for the awning peg.

Starting with the two red poles, insert the ring pin into the end of

the pole to bring the pole under tension.

Now, insert the ring pin into one end of the orange pole.

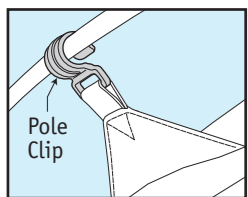

Next, go to the other end of the pole and insert the pin into the pole to bring the pole under tension.

Now work around the awning, connecting the pole clips to the poles.

### ASPECT ONLY

Insert the top section of the Steel End Pole Set into the top rear sleeve of the Awning. Next, connect the two leg poles to bring the Awning into shape.

## VISION XL ROOF TENSION POLES

To improve the awning's rigidity, the Vision XL model has a set of roof tension poles which will be inserted inside the awning once the main erection is complete.

Slot the set of tension poles together. Make sure that the adjustable end section, fitted with a lock screw, is loosely fitted.

Next, insert the fixed end of the roof tension pole into the right hand retainer sleeve. Keep the pole captive within the retainer sleeve as you walk to the opposite side of the awning.

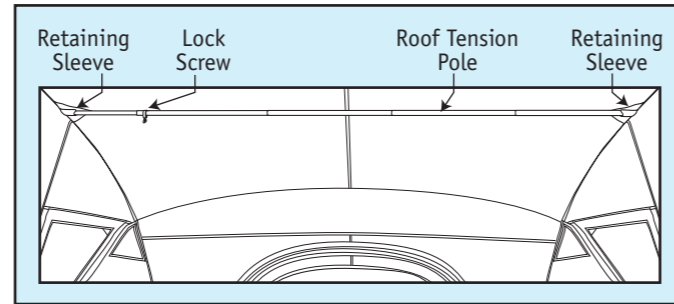

Raise the pole and insert the adjustable end section in to the left hand retainer sleeve. Carefully pull the pole and end section apart to bring them under tension, then lock in place by turning the lock screw clockwise.

## ENTRANCES

You should now ensure that all entrances to the awning are closed with all zips fully secured. If this is not done now, the awning will be out of alignment when fitting the awning pegs.

## AWNING PEGS

Starting with the four corners, secure the awning to the ground using the awning pegs.

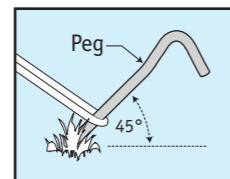

When inserting into the ground, the peg should be set at a 45 degree angle away from the awning. Pegs should be hammered into the ground using a suitable mallet and NOT pressed in with the foot. Most bent

pegs are caused by using your foot rather than a mallet. Peg removal can be made easier if you use a suitable extractor.

## GUY ROPES

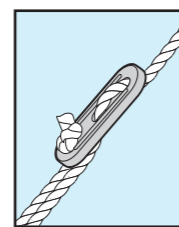

Secure each guy rope, positioning its awning peg at a suitable distance from the awning.

Once in position, tighten the ropes equally to bring the awning into its natural shape. DO NOT over tighten. To tighten, Hold the rope above the slider and pull the slider up. To release, again hold the rope above the slider and pull the slider down.

Remember that all guy ropes are a trip hazard especially in the dark.

## FRONT ENTRANCE

The front entrance is single skinned and can either be rolled back or removed completely. When closed, the zip cover/baffle must be carefully pressed into place ensuring the Velcro tabs are aligned and the skirt correctly positioned, secured by awning pegs, to avoid water ingress should it rain.

## SIDE ENTRANCE VISION XL ONLY

The side entrances are single skinned and can be rolled back and retained by a set of loops and toggles.

When closed, the zip cover/baffle must be carefully pressed into place ensuring the Velcro tabs are aligned and the skirt correctly positioned, secured by tent pegs, to avoid water ingress should it rain.

## WINDOWS

All windows have curtains which can be closed and are secured in place with hook and loop tape. When open, carefully roll the curtain and secure with toggle and loop.

## SAFETY

It is advisable to have a 'Fire' bucket filled with water, placed outside the awning. Hopefully it will never be needed, but if it is, you will be glad you made the effort.

The awning's fabric is fire retardant, NOT fire proof and therefore you must not smoke or use a naked flame in or near the awning. This includes the traditional 'camp fire'.

Guy ropes can cause a trip hazard and should be marked so that passers by can see them.

Awning pegs are also a trip hazard and should not be left 'half in'.

## CLEANING, STORING AND REPAIRS

### Cleaning...

Both inside and outside of the awning should only be cleaned using fresh clean water and a damp cloth. Do not use detergents or chemical cleaners.

The inner ground sheet can be washed with a mild detergent.

### Storing...

The awning is best stored in its original carry-bag, however, if the awning is dismantled when wet, you MUST not leave it stored until it has been thoroughly dried. After a wet pack-up, erect the awning as soon as possible and allow to fully dry naturally before repacking in the carry-bag.

If stored when wet, the awning will suffer from mildew and will become unusable.

### Repairs...

Repairs to the awning should only be made by the manufacturer's recommended agents. Repairs made by an unauthorised party will make the manufacturers warranty void.

## STORM AND WEATHER SUITABILITY

This awning is designed for light use in normal weather conditions. It is not suitable for storms, gales, sub zero or tropical conditions.

## UV DETERIORATION

Prolonged exposure to direct sunlight can weaken the fabric of the awning. To avoid the risk of UV Deterioration, site the awning in a shaded area, where it will be protected from exposure to strong sunlight.

## MOISTURE

Moisture collecting on the inside of the awning fabric is condensation caused by the occupier. It is NOT a sign of leakage.

Note that condensation or damage caused by it, is NOT covered by the manufacturer's warranty.

## SEAMS

This awning has all its main seams hot air taped to help prevent leakage. The remaining seams should be treated with a seam sealant to maximize the awning's weatherproofing.

Seam sealant should also be applied to main seams where the tape has lost adhesion or has been damaged (tie points or suspension points for example).

Seam sealant is available from your SunnCamp stockist.

## DISMANTLING

To dismantle the awning, simply reverse the erection procedure.

All poles must be dismantled and the awning should be carefully rolled prior to placing back in the carry-bag.